



Volvo V40
(2000-2001)



Wiring Diagrams and Electric Model Year 2001

Contents

Abbreviations	3
How to use the wiring diagram.....	4
Fuses	
engine bay	6
passenger compartment	7
Relays	
engine bay and passenger compartment.....	8
relay box, passenger compartment.....	10
Distribution rails.....	11
Ignition switch	14
Ground connection.....	15
Connectors.....	62
Junction points.....	84
Wiring harnesses	100
Component images	111

Group 23

Engine management system	
EMS 2000	18
EMS 2000 Turbo	20
Melco 1	22
Melco 2	24
Diesel	26

Group 26

Electric cooling fan, AC compressor	
EMS 2000	28
Melco 1	29
Melco 2	30
Diesel	31

Group 27

Cruise control	
EMS 2000	32
Melco 1	32
Melco 2	33
Diesel	34

Group 32/33

Starter circuit.....	35
Charging circuit	35

Group 35

Main and dipped beams	36
Fog light.....	36
Position lights	37
Parking lights.....	37
Number plate lighting	37
Headlight adjustment	38
Instrument and control lighting.....	39
Interior lighting	40
Vanity mirror lighting	40
Cargo compartment lighting	40
Reversing lights	42
Brake lights	42
Bulb failure sensor	42

Continued on next page

Order number TP 3949032
Replaces earlier manual TP3949031

Volvo retains the right to make amendments

Contents

Group 36

Key-inserted warning.....	40
Indicators and warning lights	43
Wiper/washer	
windscreen	44
headlights.....	44
rear window	44
Cigarette lighter.....	45
Horn	45
Electronic immobilizer	46
Theft alarm	
EO/OS.....	54
USA.....	56

Group 37

Diagnostic system.....	47
------------------------	----

Group 38

Seat belt reminder	48
Combination instrument.....	49

Group 39

Radio.....	50
------------	----

Group 43

Automatic transmission.....	51
-----------------------------	----

Group 59

ABS brake system.....	52
DSA dynamic stability assistance	52

Group 83

Power sunroof.....	40
Power windows.....	53
Central lock	
EU/OS.....	54
USA.....	56

Group 84

Power door mirrors	53
Heated door mirrors.....	57
Heated rear window	57

Group 85

Heated seats	58
Power seats	59

Group 87

Climate control system.....	60
-----------------------------	----

Group 88







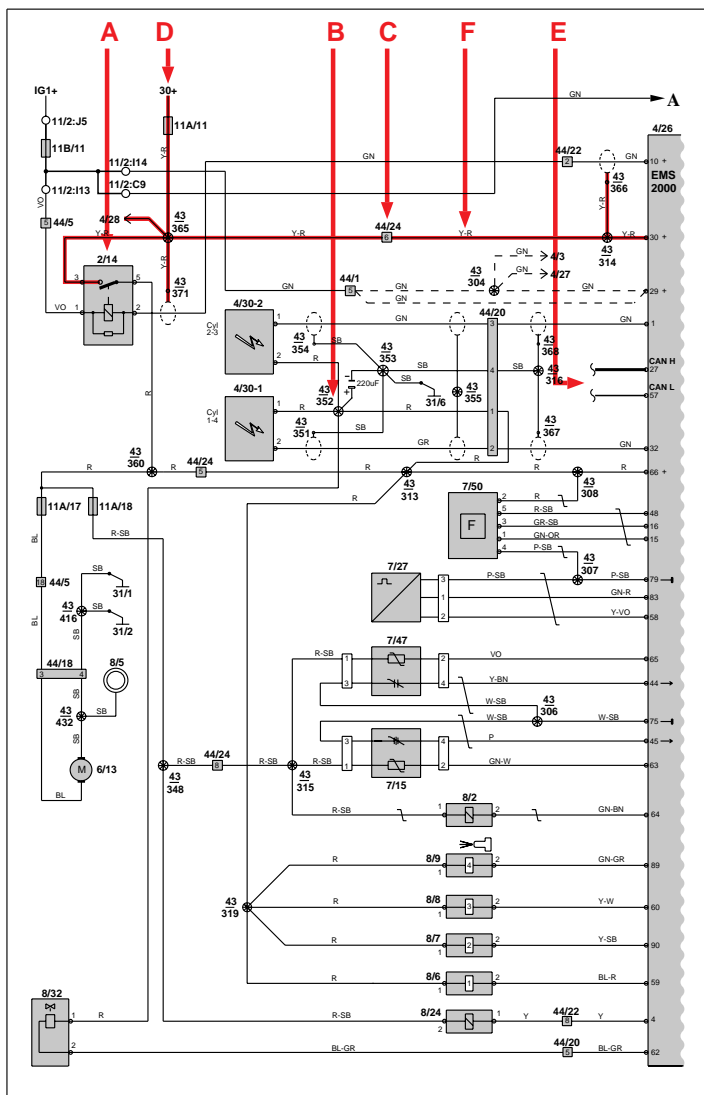





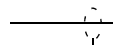

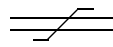
Supplemental Restraint System (SRS).....	61
--	----

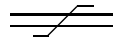
List of components (pull-out) at the end of the manual

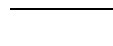
How to use the wiring diagram

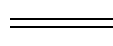

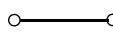
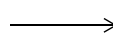
List of symbols

-  = System voltage
-  = Ground connection via cable harness
-  = Ground connection on component/chassis
-  = Screened wire
-  = Junction point
-  = Twisted cable
-  = Electrical connection
-  = Variant
-  = CAN communication
-  = CAN high signal (CAN H)
-  = CAN low signal (CAN L)
-  = Serial communication
-  = DIN cable, coaxial cable, etc.
-  = Data communication
-  = CAN communication
-  = Connection with fuse box
-  = Further connection to...
-  = Connector between wiring harnesses
-  = Connector connected to component

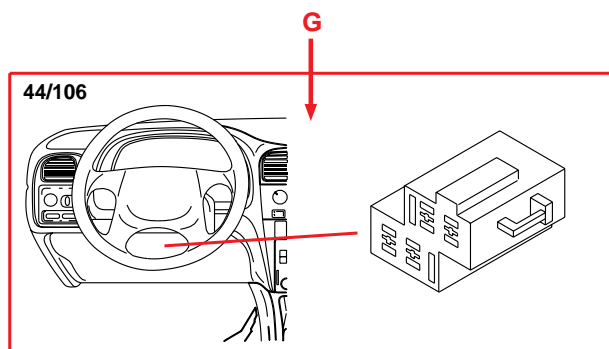

Engine control system EMS 2000

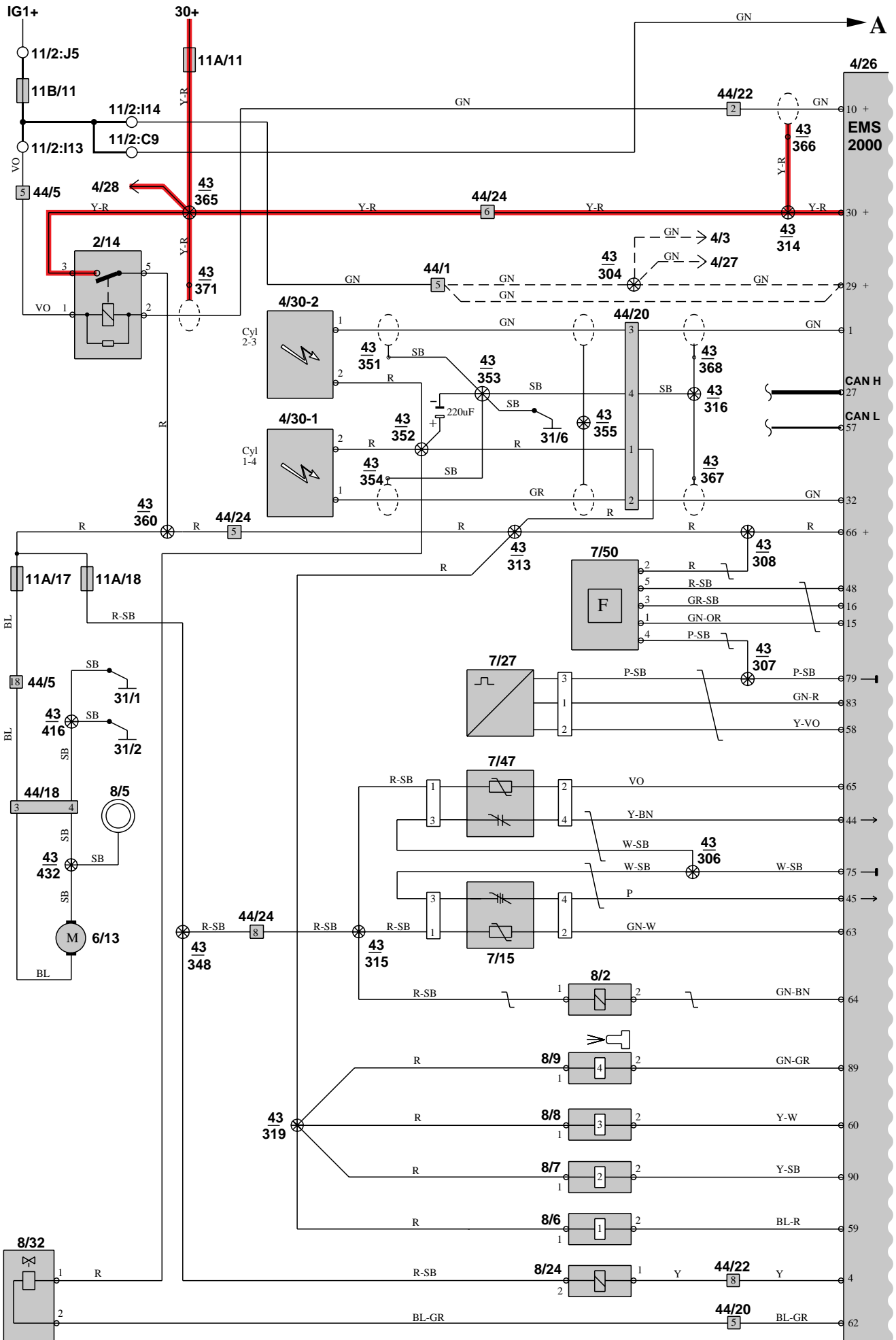

Passenger compartment cable harness

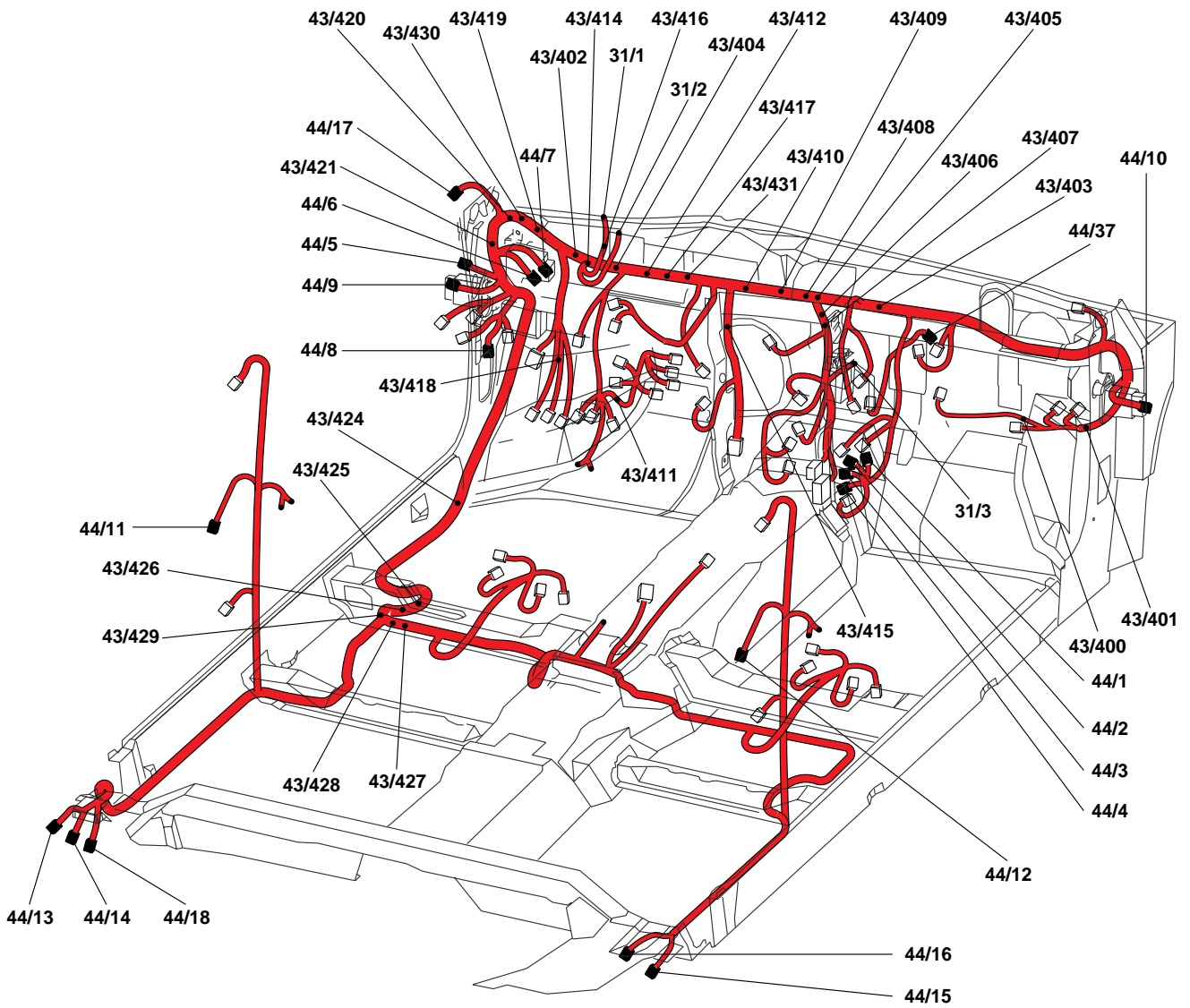

Cable harness, dashboard

